

# MANUAL DE MONTAJE

## A4



**MAMPARA ANGULAR DE DUCHA**

2 HOJAS CORREDERAS + 2 FIJAS

# A4

## 1

PRESENTAR "U" EN PARED  
Y MARCAR LOS TALADROS  
EN AMBOS LADOS.

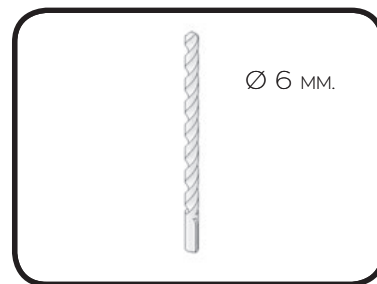
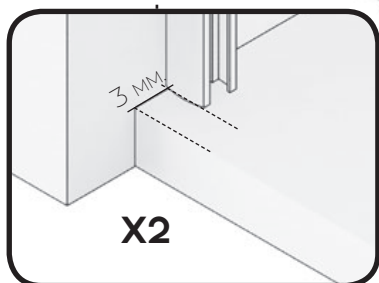

## 2

TALADRAR CON  
BROCA Ø 6 MM



## 3

ATORNILLAR LA "U" A PARED  
USANDO TACOS DE N° 6  
TORNILLOS 4,2 x 32.  
EN AMBOS LADOS.



# 4

COLOCAR GOMAS ESTANQUEIDAD INFERIOR FIJOS E INTRODUCIR LOS CRISTALES FIJO EN LA "U" APOYANDO SOBRE ÉSTA.

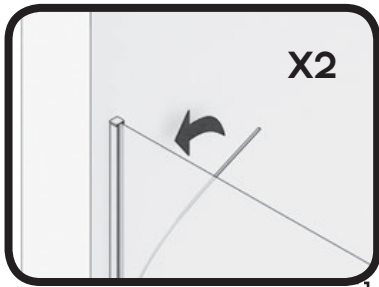

# 5

ENGOMAR CRISTALES FIJOS A "U" Y COLOCAR LAS PINZAS GUÍA INFERIOR EN LOS EXTREMOS DE LOS VIDRIOS.

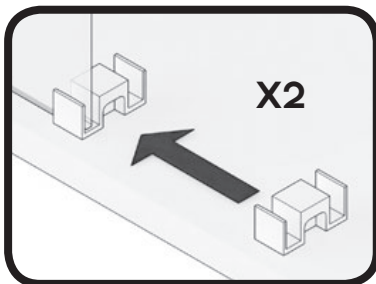

PINZA GUIA INFERIOR

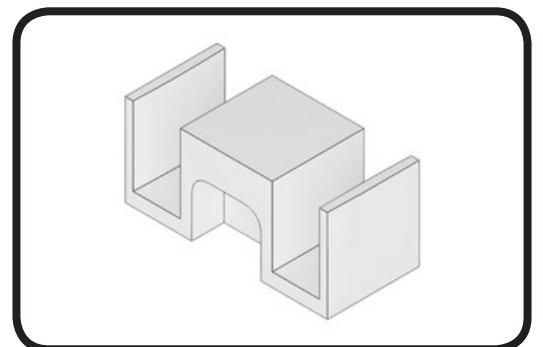

A4

6

MONTAR CODO UNIÓN GUÍAS.

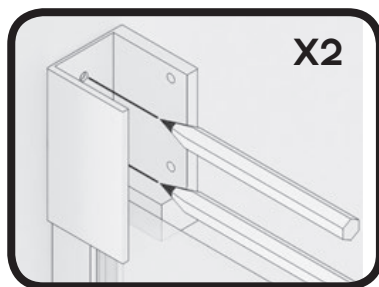
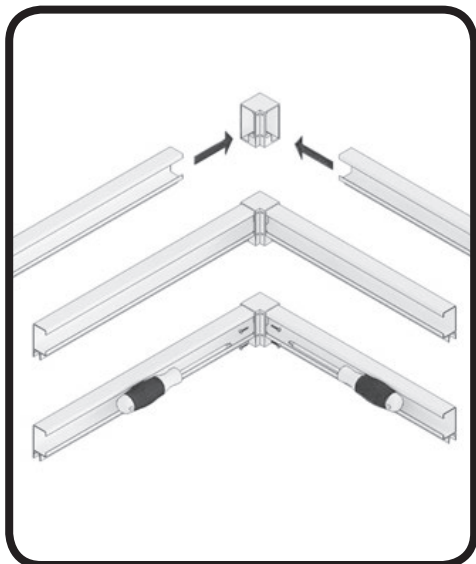

7

PRESENTAR GUÍA SUPERIOR CON VASOS SOBRE LOS VIDRIOS FIJOS, NIVELAR Y MARCAR LOS TALADROS.

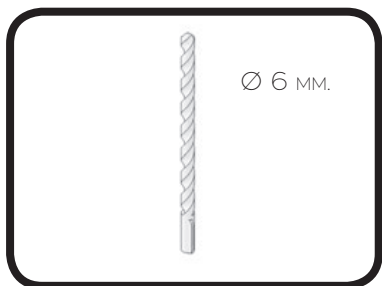

8

TALADRAR CON BROCA DE Ø 6 MM.



RETIRAR CRISTALES FIJOS SI FUESE NECESARIO..

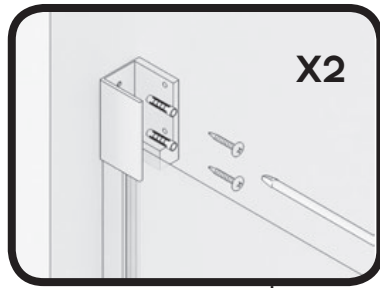

9

ATORNILLAR LOS VASOS SOPORTE GUÍA SUPERIOR COGIDAS A PARED.



10

INTRODUCIR EN LAS GUÍAS LOS RODAMIENTOS Y LOS TOPES.

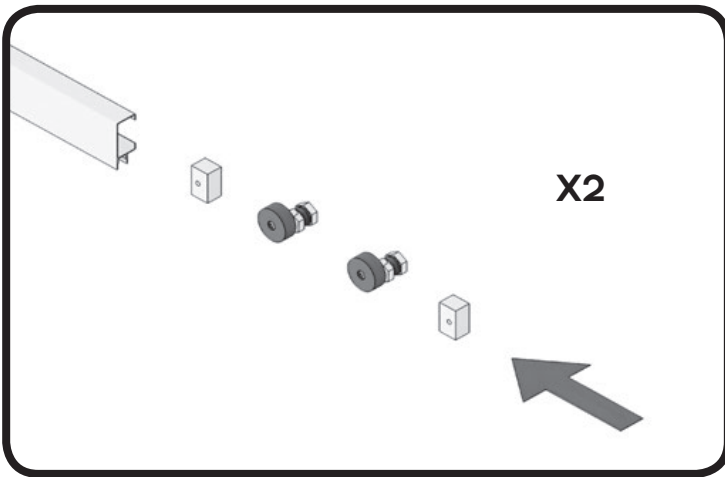

11

COLOCAR LA GUÍA SUPERIOR EN LOS VASOS COGIDAS A PARED Y FIJAR LA COGIDAS A LA GUÍA MEDIANTE TORNILLOS PRISIONEROS. ENGOMAR CRISTALES FIJOS A GUÍA SUPERIOR

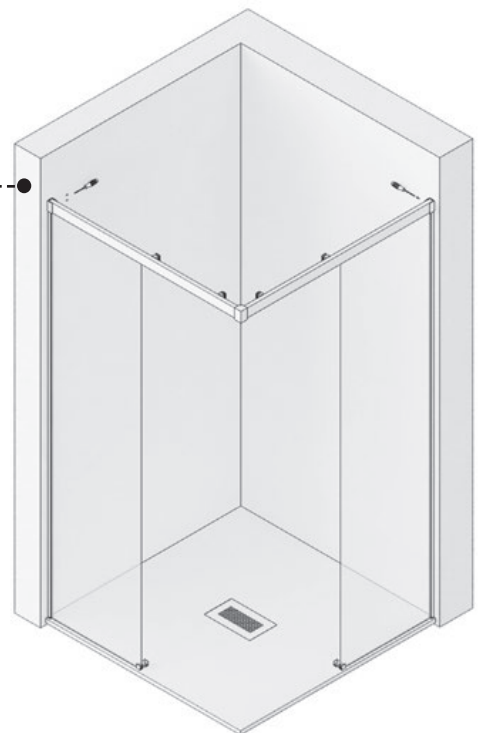
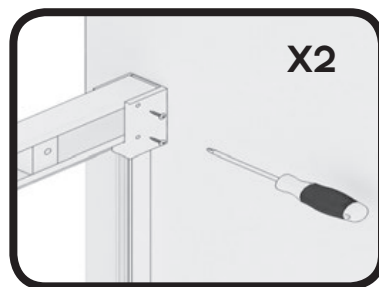

# 12

COLOCAR LAS HOJAS CORREDERAS EN LOS RODAMIENTOS VALIENDOSE DE DOS LLAVES FIJAS 20 MM PARA GRADUAR Y FIJAR, INTRODUCIENDO PREVIAMENTE LA GOMA DE "U" EN EL CANTO INFERIOR.

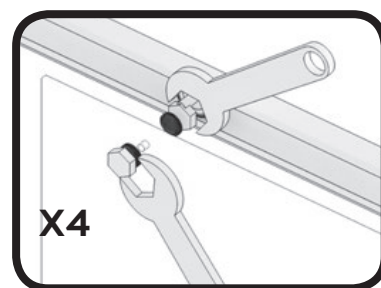
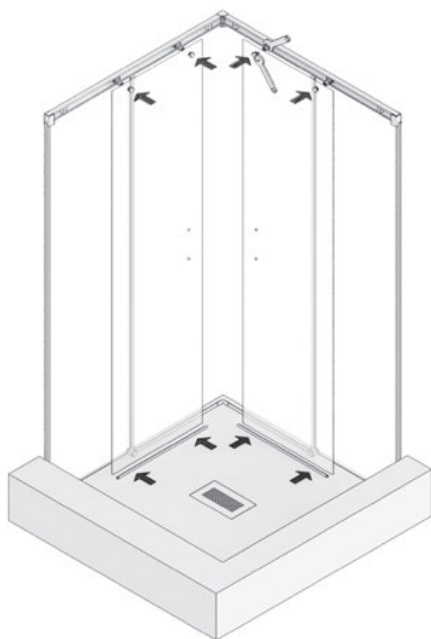

# 13

COLOCAR LAS GOMAS DE CRUCE, UNA EN EL FIJO Y OTRA EN LA HOJA CORREDERA COLOCAR EL ASA TIRADOR.

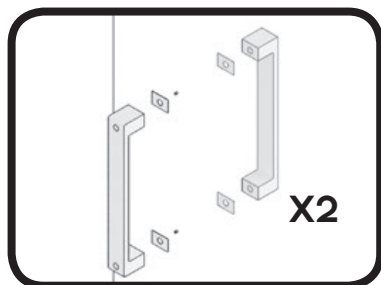
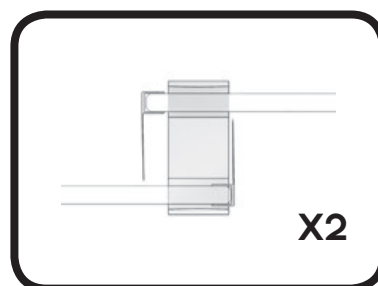

# 14

COLOCAR LOS CIERRES GOMA IMÁN EN LOS EXTREMOS DE LAS HOJAS CORREDERAS.

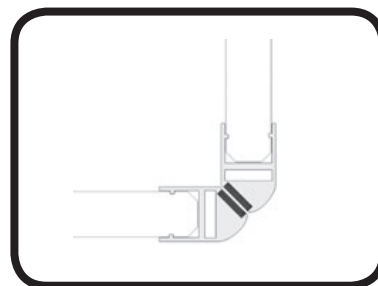

# 15

FIJAR LOS TOPES FRENO  
MEDIANTE LOS TORNILLOS  
PRISIONEROS..

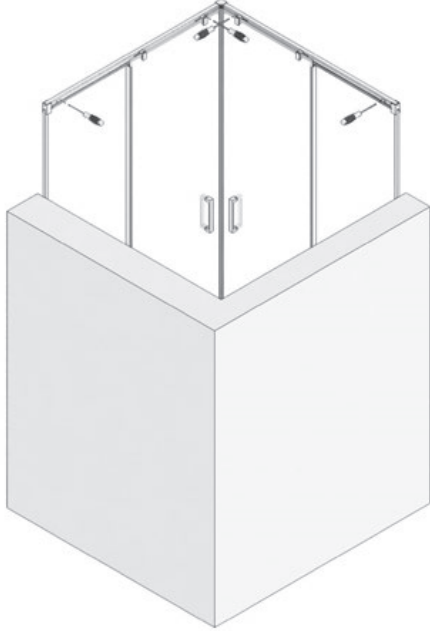
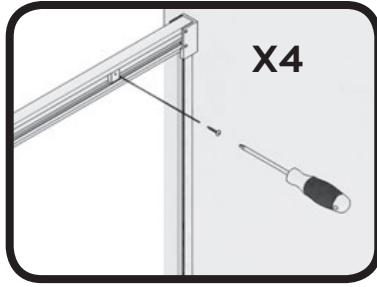

# 16

CORTAR LOS PERFILES BAJO A MEDIDA. DESDE LA PINZA  
BAJA HASTA EL CODO UNIÓN DE LOS FIJOS Y COLOCAR  
POR DELANTE DE LAS HOJAS CORREDERAS

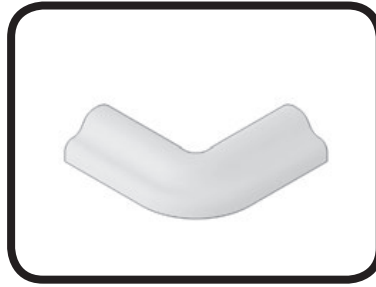

# 17

PEGAR PERFIL BAJO CON SILICONA.

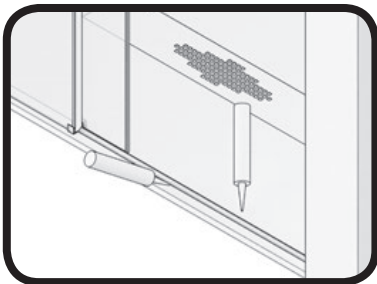

# 18

SELLAR CON SILICONA  
EL CONTORNO EXTERIOR DE LA  
MAMPARA.



# A4

